

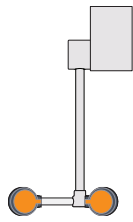

□ G1798 Eye/Face Wash, Wall Mounted AutoFlow™ 90° Swing-Down, All-Stainless Steel

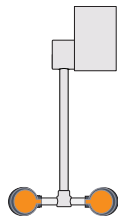

□ G1798LH-L



□ G1798LH

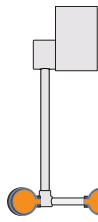

□ G1798LH-R

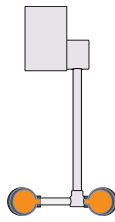

□ G1798L

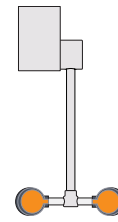

□ G1798

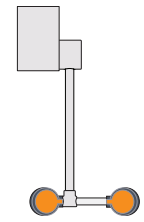

□ G1798R

Units shown in plan view



Model G1798LH-L Shown

Application: All-stainless steel AutoFlow™ eye/face wash for mounting on wall. Unit is constructed entirely in stainless steel. Ideal for use in highly corrosive environments, cleanrooms and pharmaceutical applications. Spray heads swing down from storage to operational position, activating water flow. Available in a variety of spray head configurations to minimize obstructions at a sink. **Note:** *If unit is not installed at a sink, floor drain should be provided underneath unit to prevent accumulation of water on floor.*

Spray Head Assembly: Two FS-Plus™ spray heads. Each head has a “flip top” dust cover, internal flow control and filter to remove impurities from the water flow.

Valve: 1/2" IPS stainless steel plug-type valve with PTFE coated O-ring seals. Swinging head assembly down from storage to operational position opens orifice and activates water flow. Unit remains in operation until head assembly is returned to storage position.

Mounting: Valve is installed in Type 316 stainless steel housing. Mount housing on wall using anchors or other mounting hardware.

Construction: Type 316 stainless steel.

Supply: 3/8" NPT female inlet.

Sign: ANSI-compliant identification sign.

Quality Assurance: Unit is completely assembled and water tested prior to shipment.

Available Options

□ **G6020** Thermostatic mixing valve precisely blends hot and cold water to deliver tepid water as required by ANSI Z358.1-2014. Refer to “Thermostatic Mixing Valves” section for complete technical and product selection information.





□ G1798 Eye/face wash, Wall Mounted AutoFlow™ 90° Swing-Down, All-Stainless Steel

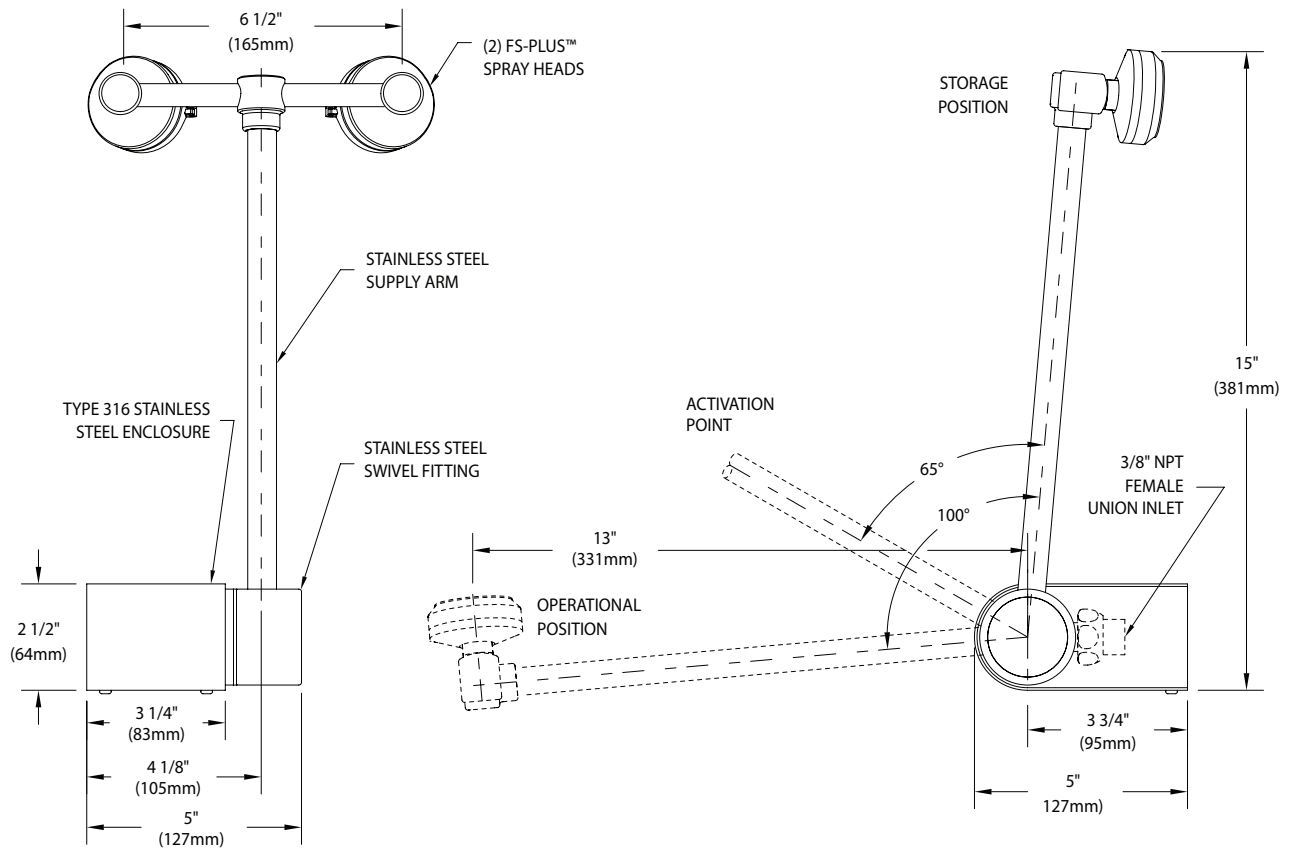
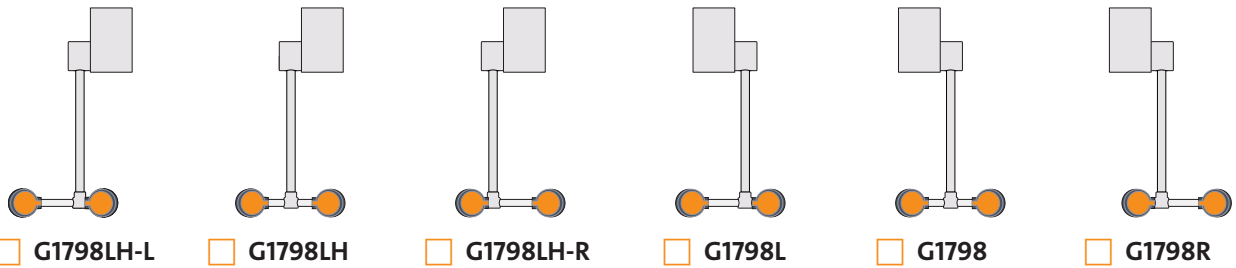

NOTES:

1. SWINGING OUTLET HEAD ASSEMBLY DOWN 100 DEGREES FROM VERTICAL TO HORIZONTAL POSITION ACTIVATES WATER FLOW.
2. EACH FS-PLUS™ SPRAY HEAD HAS A "FLIP-TOP" DUST COVER, INTERNAL FLOW CONTROL AND FILTER TO REMOVE IMPURITIES FROM THE WATER FLOW.
3. MOUNT HOUSING ON WALL USING ANCHORS OR OTHER HARDWARE.
4. UNIT SHOULD BE INSTALLED SO THAT WATER FLOW PATTERN IS POSITIONED BETWEEN 33" AND 53" ABOVE FLOOR.
5. VALVE BEGINS AT "ACTIVATION POINT" SHOWN ABOVE.

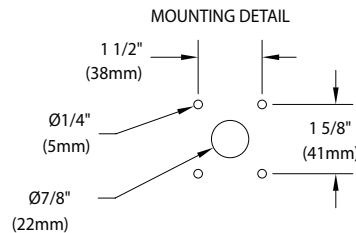

THIS SPACE FOR ARCHITECT/ENGINEER APPROVAL

Sign Included



Due to continuing product improvement, the information contained in this document is subject to change without notice. All dimensions are ± 1/4" (6mm). rev. 101519

